

ŁAŃCUCHY ROLKOWE Z ZABIERAKAMI

ZABIERAKI A1/02

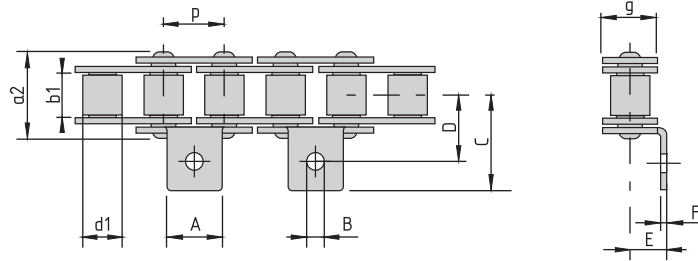

ISO	podziałka P		b1	d1	a2	g	A	B	C	D	E	F	F _B	q
	mm	cale	mm min	mm max	mm max	mm max	mm	mm	mm max	mm	mm	mm	min N	[kg/m] ≈
06B-1	9,525	3/8"	5,72	6,35	13,50	8,26	8,00	3,50	13,50	9,50	6,50	1,03	9.100	0,46
08B-1	12,70	1/2"	7,75	8,51	17,00	11,81	9,50	4,30	18,60	14,10	8,40	1,40	18.200	0,77
10B-1	15,875	5/8"	9,65	10,16	19,60	14,73	14,10	5,20	23,80	15,90	10,40	1,63	22.700	1,04
12B-1	19,05	3/4"	11,68	12,07	22,70	16,13	15,80	5,60	25,80	17,50	12,00	1,80	29.500	1,35
16B-1	25,40	1"	17,02	15,88	36,10	21,08	19,00	6,80	37,40	25,40	15,90	3,00	58.000	3,09

ZABIERAKI K1/02

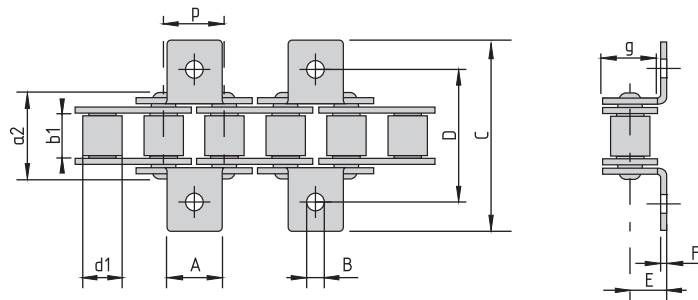

ISO	podziałka P		b1	d1	a2	g	A	B	C	D	E	F	F _B	q
	mm	cale	mm min	mm max	mm max	mm max	mm	mm	mm max	mm	mm	mm	min N	[kg/m] ≈
06B-1	9,525	3/8"	5,72	6,35	13,50	8,26	8,00	3,50	27,00	19,00	6,50	1,03	9.100	0,51
08B-1	12,70	1/2"	7,75	8,51	17,00	11,81	9,50	4,30	37,20	28,20	8,40	1,40	18.200	0,85
10B-1	15,875	5/8"	9,65	10,16	19,60	14,73	14,10	5,20	47,60	31,80	10,40	1,63	22.700	1,13
12B-1	19,05	3/4"	11,68	12,07	22,70	16,13	15,80	5,60	51,60	35,00	12,00	1,80	29.500	1,45
16B-1	25,40	1"	17,02	15,88	36,10	21,08	19,00	6,80	74,80	50,80	15,90	3,00	58.000	3,48

ZABIERAKI A1/01

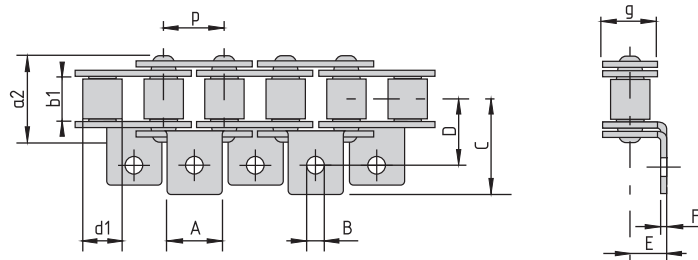

ISO	podziałka P		b1	d1	a2	g	A	B	C	D	E	F	F _B	q
	mm	cale	mm min	mm max	mm max	mm max	mm	mm	mm max	mm	mm	mm	min N	[kg/m] ≈
06B-1	9,525	3/8"	5,72	6,35	13,50	8,26	8,00	3,50	13,50	9,50	6,50	1,03	9.100	0,51
08B-1	12,70	1/2"	7,75	8,51	17,00	11,81	9,50	4,30	18,60	14,10	8,40	1,40	18.200	0,85
10B-1	15,875	5/8"	9,65	10,16	19,60	14,73	14,10	5,20	23,80	15,90	10,40	1,63	22.700	1,13
12B-1	19,05	3/4"	11,68	12,07	22,70	16,13	15,80	5,60	25,80	17,50	12,00	1,80	29.500	1,45
16B-1	25,40	1"	17,02	15,88	36,10	21,08	19,00	6,80	37,40	25,40	15,90	3,00	58.000	3,48

ŁAŃCUCHY ROLKOWE Z ZABIERAKAMI

ZABIERAKI K1/01

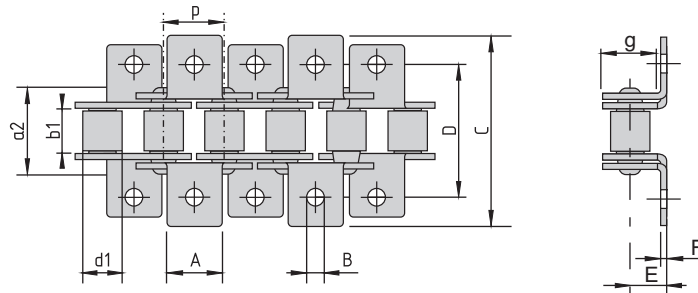

ISO	podziałka P		b1	d1	a2	g	A	B	C	D	E	F	F _B	q
	mm	cale	mm min	mm max	mm max	mm max	mm	mm	mm max	mm	mm	mm	min N	[kg/m] ≈
06B-1	9,525	3/8"	5,72	6,35	13,50	8,26	8,00	3,50	27,00	19,00	6,50	1,03	9.100	0,61
08B-1	12,70	1/2"	7,75	8,51	17,00	11,81	9,50	4,30	37,20	28,20	8,40	1,40	18.200	1,01
10B-1	15,875	5/8"	9,65	10,16	19,60	14,73	14,10	5,20	47,60	31,80	10,40	1,63	22.700	1,32
12B-1	19,05	3/4"	11,68	12,07	22,70	16,13	15,80	5,60	51,60	35,00	12,00	1,80	29.500	1,66
16B-1	25,40	1"	17,02	15,88	36,10	21,08	19,00	6,80	74,80	50,80	15,90	3,00	58.000	4,27

ZABIERAKI A2/02

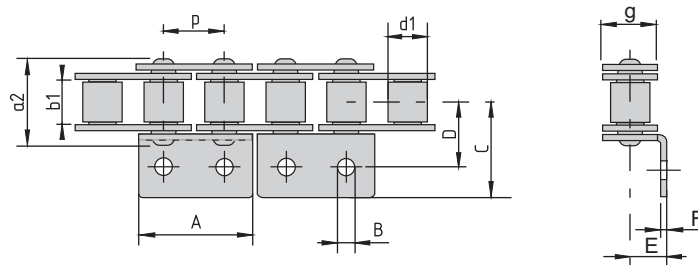

ISO	podziałka P		b1	d1	a2	g	A	B	C	D	E	F	F _B	q
	mm	cale	mm min	mm max	mm max	mm max	mm	mm	mm max	mm	mm	mm	min N	[kg/m] ≈
06B-1	9,525	3/8"	5,72	6,35	13,50	8,26	17,60	3,50	13,50	9,50	6,50	1,03	9.100	0,51
08B-1	12,70	1/2"	7,75	8,51	17,00	11,81	23,20	4,30	18,60	14,10	8,40	1,40	18.200	0,85
10B-1	15,875	5/8"	9,65	10,16	19,60	14,73	29,30	5,20	23,80	15,90	10,40	1,63	22.700	1,13
12B-1	19,05	3/4"	11,68	12,07	22,70	16,13	33,00	5,60	30,50	17,50	12,00	1,80	29.500	1,45
16B-1	25,40	1"	17,02	15,88	36,10	21,08	46,00	6,80	39,10	25,40	15,90	3,00	58.000	3,48

ZABIERAKI K2/02

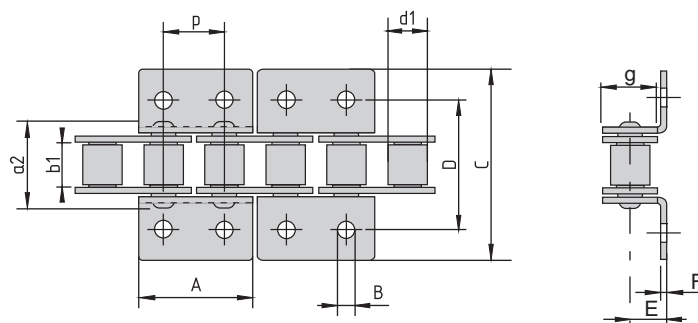

ISO	podziałka P		b1	d1	a2	g	A	B	C	D	E	F	F _B	q
	mm	cale	mm min	mm max	mm max	mm max	mm	mm	mm max	mm	mm	mm	min N	[kg/m] ≈
06B-1	9,525	3/8"	5,72	6,35	13,50	8,26	17,60	3,50	27,00	19,00	6,50	1,03	9.100	0,61
08B-1	12,70	1/2"	7,75	8,51	17,00	11,81	23,20	4,30	37,20	28,20	8,40	1,40	18.200	1,01
10B-1	15,875	5/8"	9,65	10,16	19,60	14,73	29,30	5,20	47,60	31,80	10,40	1,63	22.700	1,32
12B-1	19,05	3/4"	11,68	12,07	22,70	16,13	33,00	5,60	61,00	35,00	12,00	1,80	29.500	1,66
16B-1	25,40	1"	17,02	15,88	36,10	21,08	46,00	6,80	78,20	50,80	15,90	3,00	58.000	4,27

ŁAŃCUCHY ROLKOWE Z ZABIERAKAMI

ZABIERAKI M1/02

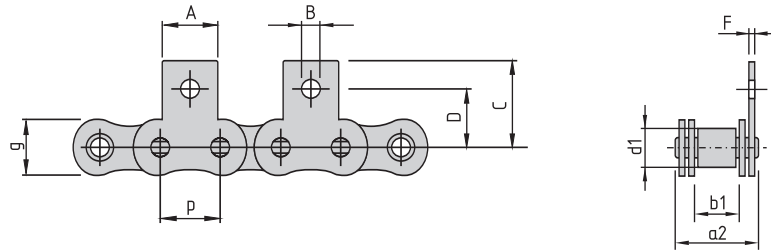

ISO	podziałka P		b1 mm min	d1 mm max	a2 mm max	g mm max	A mm	B mm	C mm max	D mm	F mm	F _B min N	q [kg/m] ≈
	mm	cale											
06B-1	9,525	3/8"	5,72	6,35	13,50	8,26	8,00	3,50	13,50	9,50	1,03	9.100	0,46
08B-1	12,70	1/2"	7,75	8,51	17,00	11,81	9,50	4,30	18,40	14,10	1,40	18.200	0,77
10B-1	15,875	5/8"	9,65	10,16	19,60	14,73	14,10	5,20	24,70	15,90	1,63	22.700	1,04
12B-1	19,05	3/4"	11,68	12,07	22,70	16,13	15,80	5,60	26,60	17,90	1,80	29.500	1,35
16B-1	25,40	1"	17,02	15,88	36,10	21,08	19,00	6,80	35,00	26,00	3,00	58.000	3,09

ZABIERAKI MK1/02

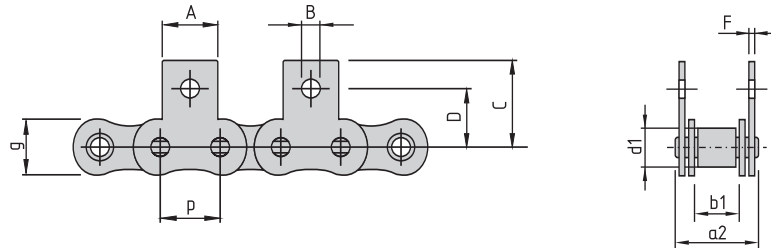

ISO	podziałka P		b1 mm min	d1 mm max	a2 mm max	g mm max	A mm	B mm	C mm max	D mm	F mm	F _B min N	q [kg/m] ≈
	mm	cale											
06B-1	9,525	3/8"	5,72	6,35	13,50	8,26	8,00	3,50	13,50	9,50	1,03	9.100	0,51
08B-1	12,70	1/2"	7,75	8,51	17,00	11,81	9,50	4,30	18,40	14,10	1,40	18.200	0,85
10B-1	15,875	5/8"	9,65	10,16	19,60	14,73	14,10	5,20	24,70	15,90	1,63	22.700	1,13
12B-1	19,05	3/4"	11,68	12,07	22,70	16,13	15,80	5,60	26,60	17,90	1,80	29.500	1,45
16B-1	25,40	1"	17,02	15,88	36,10	21,08	19,00	6,80	35,00	26,00	3,00	58.000	3,48

ZABIERAKI M1/01

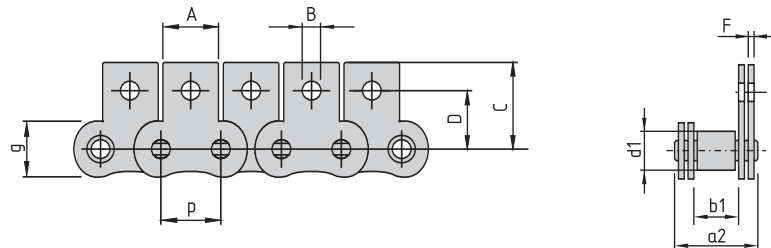

ISO	podziałka P		b1 mm min	d1 mm max	a2 mm max	g mm max	A mm	B mm	C mm max	D mm	F mm	F _B min N	q [kg/m] ≈
	mm	cale											
06B-1	9,525	3/8"	5,72	6,35	13,50	8,26	8,00	3,50	13,50	9,50	1,03	9.100	0,51
08B-1	12,70	1/2"	7,75	8,51	17,00	11,81	9,50	4,30	18,40	14,10	1,40	18.200	0,85
10B-1	15,875	5/8"	9,65	10,16	19,60	14,73	14,10	5,20	24,70	15,90	1,63	22.700	1,13
12B-1	19,05	3/4"	11,68	12,07	22,70	16,13	15,80	5,60	26,60	17,90	1,80	29.500	1,45
16B-1	25,40	1"	17,02	15,88	36,10	21,08	19,00	6,80	35,00	26,00	3,00	58.000	3,48

ŁAŃCUCHY ROLKOWE Z ZABIERAKAMI

ZABIERAKI MK1/01

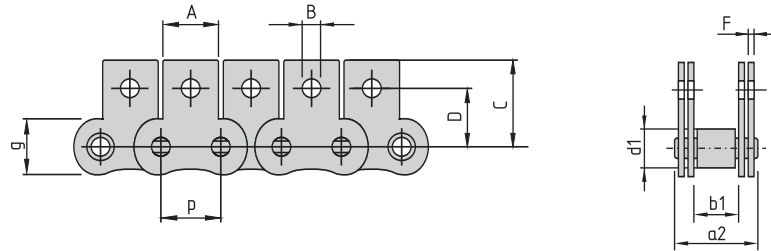

ISO	podziałka P		b1 mm min	d1 mm max	a2 mm max	g mm max	A mm	B mm	C mm max	D mm	F mm	F _B min N	q [kg/m] ≈
	mm	cale											
06B-1	9,525	3/8"	5,72	6,35	13,50	8,26	8,00	3,50	13,50	9,50	1,03	9.100	0,61
08B-1	12,70	1/2"	7,75	8,51	17,00	11,81	9,50	4,30	18,40	14,10	1,40	18.200	1,01
10B-1	15,875	5/8"	9,65	10,16	19,60	14,73	14,10	5,20	24,70	15,90	1,63	22.700	1,32
12B-1	19,05	3/4"	11,68	12,07	22,70	16,13	15,80	5,60	26,60	17,90	1,80	29.500	1,66
16B-1	25,40	1"	17,02	15,88	36,10	21,08	19,00	6,80	35,00	26,00	3,00	58.000	4,27

ZABIERAKI M2/02

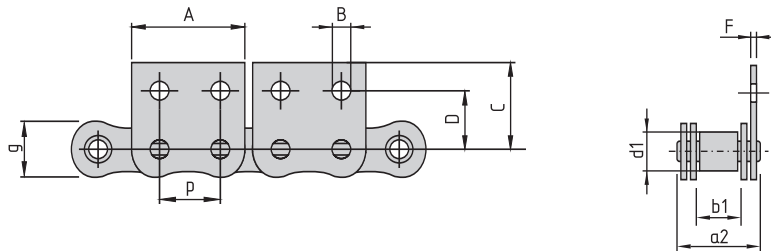

ISO	podziałka P		b1 mm min	d1 mm max	a2 mm max	g mm max	A mm	B mm	C mm max	D mm	F mm	F _B min N	q [kg/m] ≈
	mm	cale											
06B-1	9,525	3/8"	5,72	6,35	13,50	8,26	17,60	3,20	13,50	9,50	1,03	9.100	0,51
08B-1	12,70	1/2"	7,75	8,51	17,00	11,81	23,20	4,30	18,40	14,10	1,40	18.200	0,85
10B-1	15,875	5/8"	9,65	10,16	19,60	14,73	29,30	5,20	24,70	15,90	1,63	22.700	1,13
12B-1	19,05	3/4"	11,68	12,07	22,70	16,13	33,00	5,60	31,30	17,90	1,80	29.500	1,45
16B-1	25,40	1"	17,02	15,88	36,10	21,08	45,90	6,80	36,60	26,00	3,00	58.000	3,48

ZABIERAKI MK2/02

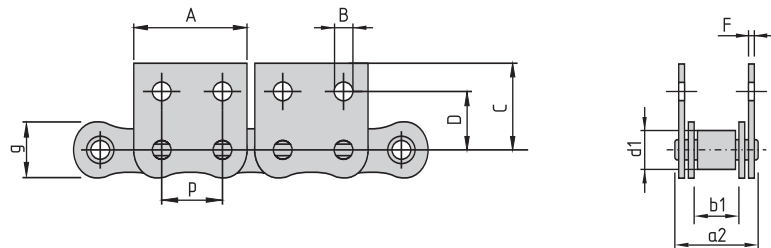

ISO	podziałka P		b1 mm min	d1 mm max	a2 mm max	g mm max	A mm	B mm	C mm max	D mm	F mm	F _B min N	q [kg/m] ≈
	mm	cale											
06B-1	9,525	3/8"	5,72	6,35	13,50	8,26	17,60	3,20	13,50	9,50	1,03	9.100	0,61
08B-1	12,70	1/2"	7,75	8,51	17,00	11,81	23,20	4,30	18,40	14,10	1,40	18.200	1,01
10B-1	15,875	5/8"	9,65	10,16	19,60	14,73	29,30	5,20	24,70	15,90	1,63	22.700	1,32
12B-1	19,05	3/4"	11,68	12,07	22,70	16,13	33,00	5,60	31,30	17,90	1,80	29.500	1,66
16B-1	25,40	1"	17,02	15,88	36,10	21,08	45,90	6,80	36,60	26,00	3,00	58.000	4,27